



**CHENMKO ENTERPRISE CO.,LTD**

*Halogens free devices*

**SURFACE MOUNT  
Dual Silicon Transistor**

VOLTAGE 50 Volts CURRENT 150 mAmpere

**CHUMY1GP**

**APPLICATION**

\* Small Signal Amplifier .

**FEATURE**

- \* Small surface mounting type. (SC-88A/SOT-353)
- \* Pc= 150mW (Total).
- \* High saturation current capability.
- \* Includes a 2SC2412K and a 2SA1037K in one package.

**MARKING**

\* UY1

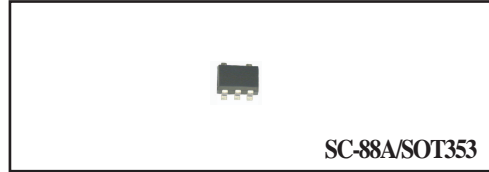

SC-88A/SOT353

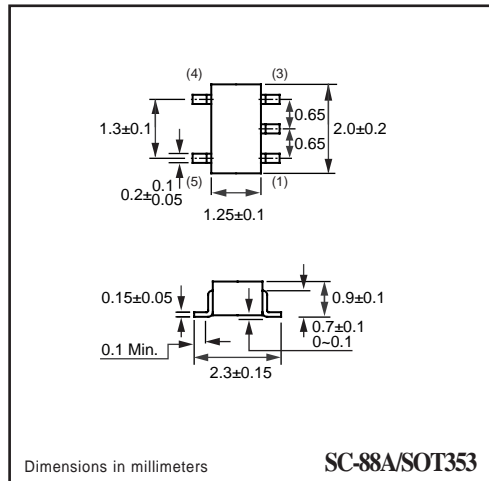

Dimensions in millimeters

SC-88A/SOT353

**CIRCUIT**

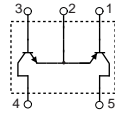

**NPN Transistor 2SC2412K LIMITING VALUES**

MAXIMUM RATINGS ( At TA = 25°C unless otherwise noted )

RATINGS	CONDITION	SYMBOL	MIN.	MAX.	UNITS
Collector - Base Voltage	Open Emitter	VCBO	-	60	Volts
Collector - Emitter Voltage	Open Base	VCEO	-	50	Volts
Emitter - Base Voltage	Open Collector	VEBO	-	7	Volts
Collector Current DC		IC	-	150	mAmps
Peak Collector Current		ICM	-	150	mAmps
Peak Base Current		IBM	-	15	mAmps
Total Power Dissipation	TA ≤ 25°C; Note 1	PTOT	-	150	mW
Storage Temperature		TSTG	-55	+150	°C
Junction Temperature		TJ	-	+150	°C
Operating Ambient Temperature		TAMB	-55	+150	°C

**Note**

2004-11

1. Transistor mounted on ceramic substrate 50mmX50mmx0.8t.

## PNP Transistor 2SA1037K LIMITING VALUES

MAXIMUM RATINGS ( At TA = 25 C unless otherwise noted )

RATINGS	CONDITION	SYMBOL	MIN.	MAX.	UNITS
Collector - Base Voltage	Open Emitter	V <sub>CB0</sub>	-	-60	Volts
Collector - Emitter Voltage	Open Base	V <sub>CEO</sub>	-	-50	Volts
Emitter - Base Voltage	Open Collector	V <sub>EB0</sub>	-	-6	Volts
Collector Current DC		I <sub>C</sub>	-	-150	mAmps
Peak Collector Current		I <sub>CM</sub>	-	-150	mAmps
Peak Base Current		I <sub>BM</sub>	-	-15	mAmps
Total Power Dissipation	TA ≤ 25°C; Note 2	P <sub>TOT</sub>	-	150	mW
Storage Temperature		T <sub>STG</sub>	-55	+150	°C
Junction Temperature		T <sub>J</sub>	-	+150	°C
Operating Ambient Temperature		T <sub>AMB</sub>	-55	+150	°C

### Note

2. Transistor mounted on ceramic substrate 50mmX50mmx0.8t.

## 2SC2412K CHARACTERISTICS

ELECTRICAL CHARACTERISTICS ( At TA = 25°C unless otherwise noted )

PARAMETERS	CONDITION	SYMBOL	MIN.	TYPE	MAX.	UNITS
Collector-base breakdown voltage	I <sub>C</sub> =50uA	BV <sub>CB0</sub>	60	-	-	Volts
Collector-emitter breakdown voltage	I <sub>C</sub> =1mA	BV <sub>CEO</sub>	50	-	-	Volts
Emitter-base breakdown voltage	I <sub>E</sub> =50uA	BV <sub>EB0</sub>	7	-	-	Volts
Collector Cut-off Current	I <sub>E</sub> =0; V <sub>CB</sub> =60V	I <sub>CBO</sub>	-	-	0.1	
Emitter Cut-off Current	I <sub>C</sub> =0; V <sub>EB</sub> =7V	I <sub>CEO</sub>	-	-	0.1	uA
DC Current Gain	V <sub>CE</sub> =6V I <sub>C</sub> =1mA	h <sub>FE</sub>	120	-	560	
Collector-Emitter Saturation Voltage	I <sub>C</sub> =50mA; I <sub>B</sub> =5mA	V <sub>CEsat</sub>	-	-	0.4	Volts
Output Collector Capacitance	I <sub>E</sub> =I <sub>E</sub> =0; V <sub>CB</sub> =12V; f=1MHz	C <sub>ob</sub>	-	2	3.5	pF
Transition Frequency	I <sub>C</sub> =2mA; V <sub>CE</sub> =12V; f=100MHz	f <sub>T</sub>	-	180	-	MHz

## 2SA1037K CHARACTERISTICS

ELECTRICAL CHARACTERISTICS ( At TA = 25°C unless otherwise noted )

PARAMETERS	CONDITION	SYMBOL	MIN.	TYPE	MAX.	UNITS
Collector-base breakdown voltage	I <sub>C</sub> =50uA	BV <sub>CB0</sub>	-60	-	-	Volts
Collector-emitter breakdown voltage	I <sub>C</sub> =1mA	BV <sub>CEO</sub>	-50	-	-	Volts
Emitter-base breakdown voltage	I <sub>E</sub> =50uA	BV <sub>EB0</sub>	-6	-	-	Volts
Collector Cut-off Current	I <sub>E</sub> =0; V <sub>CB</sub> =-60V	I <sub>CBO</sub>	-	-	-0.1	
Emitter Cut-off Current	I <sub>C</sub> =0; V <sub>EB</sub> =-6V	I <sub>EBO</sub>	-	-	-0.1	uA
DC Current Gain	V <sub>CE</sub> =-6V I <sub>C</sub> =-1mA	h <sub>FE</sub>	120	-	560	
Collector-Emitter Saturation Voltage	I <sub>C</sub> =-50mA; I <sub>B</sub> =-5mA	V <sub>CEsat</sub>	-	-	-0.5	Volts
Output Collector Capacitance	I <sub>E</sub> =I <sub>E</sub> =0; V <sub>CB</sub> =-12V; f=1MHz	C <sub>ob</sub>	-	4	5.0	pF
Transition Frequency	I <sub>E</sub> =2mA; V <sub>CE</sub> =-12V; f=100MHz	f <sub>T</sub>	-	140	-	MHz

# RATING CHARACTERISTIC CURVES ( CHUMY1GP )

## 2SC2412K Typical Electrical Characteristics

Fig.1 Grounded emitter propagation characteristics

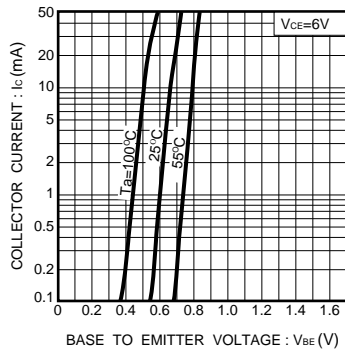

Fig.2 Grounded emitter output characteristics

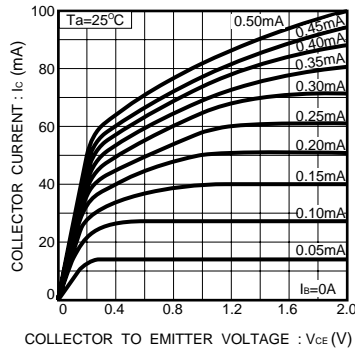

Fig.3 DC current gain vs. collector current (1)

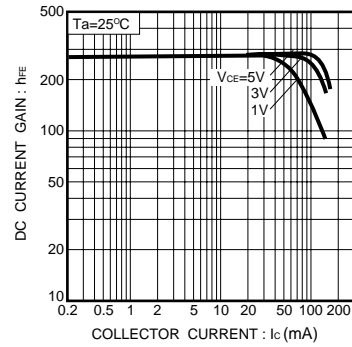

Fig.4 DC current gain vs. collector current (2)

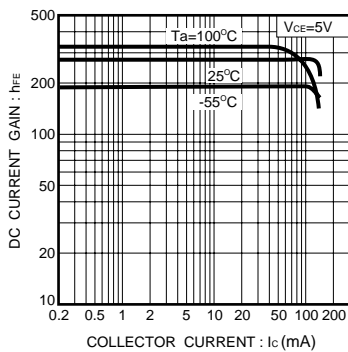

Fig.5 Collector-emitter saturation voltage vs. collector current

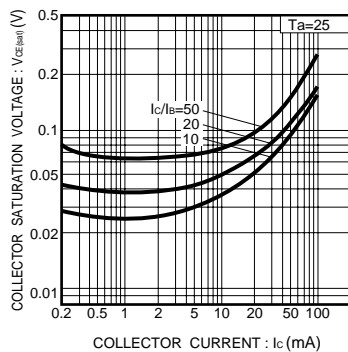

Fig.6 Collector-emitter saturation voltage vs. collector current

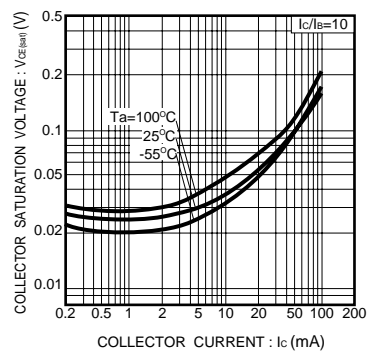

Fig.7 Gain bandwidth product vs. emitter current

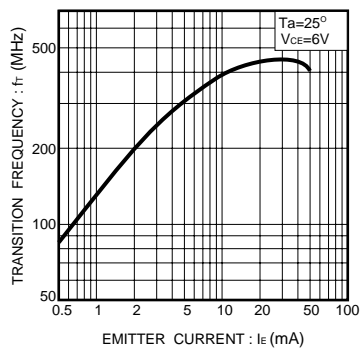
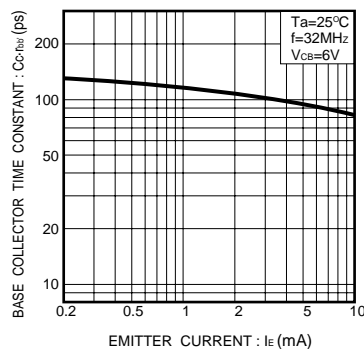

Fig.8 Base-collector time constant vs. emitter current



# RATING CHARACTERISTIC CURVES ( CHUMY1GP )

## 2SA1037K Typical Electrical Characteristics

Fig.1 Grounded emitter propagation characteristics

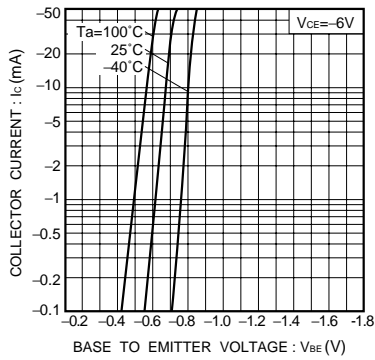

Fig.2 Grounded emitter output characteristics

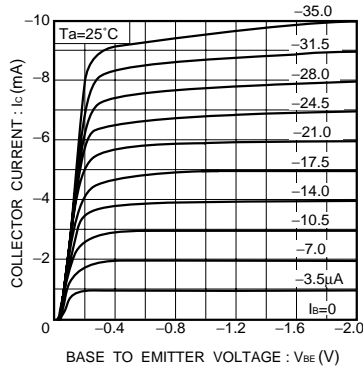

Fig.3 DC current gain vs. collector current (1)

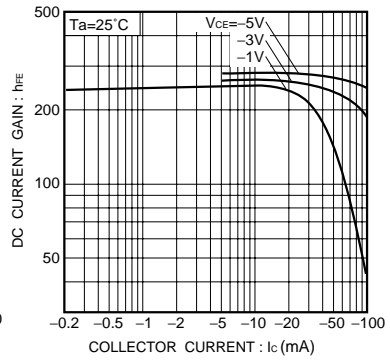

Fig.4 DC current gain vs. collector current (2)

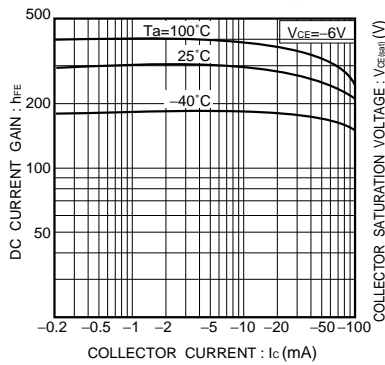

Fig.5 Collector-emitter saturation voltage vs. collector current

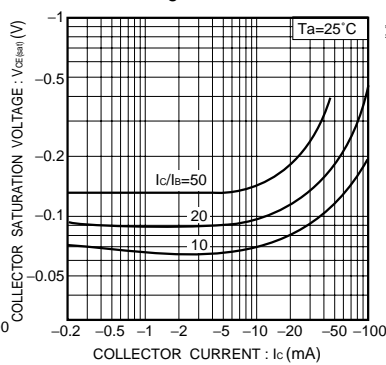

Fig.6 Collector-emitter saturation voltage vs. collector current

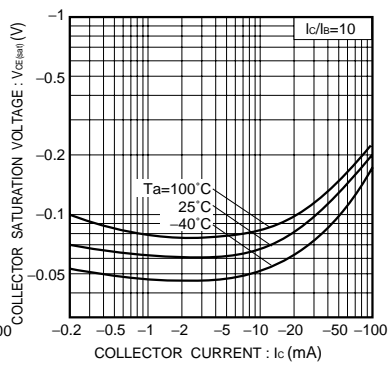

Fig.7 Gain bandwidth product vs. emitter current

